

SERIE PAMELA PLUS - PORTA E SOPRAVASCA SCORREVOLI

ISTRUZIONI DI MONTAGGIO / ASSEMBLY INSTRUCTIONS

PPP2

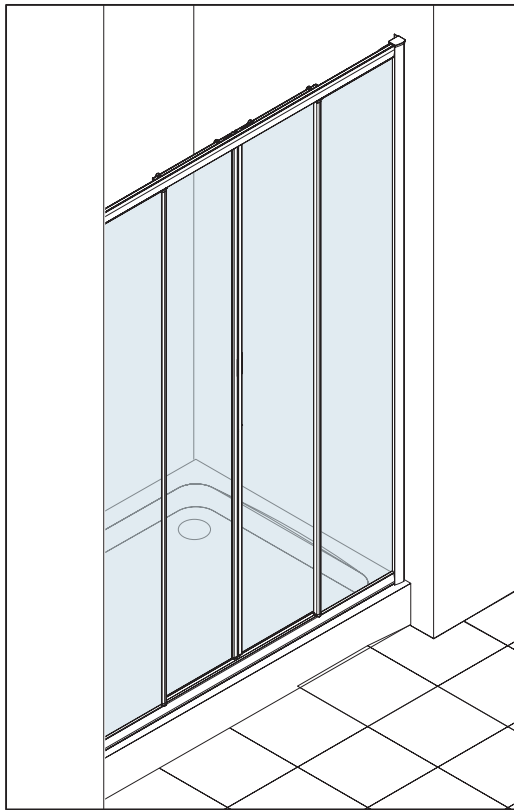

PPS1

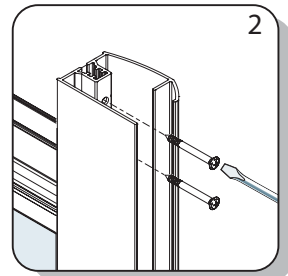
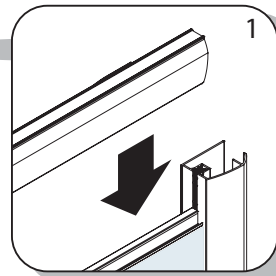
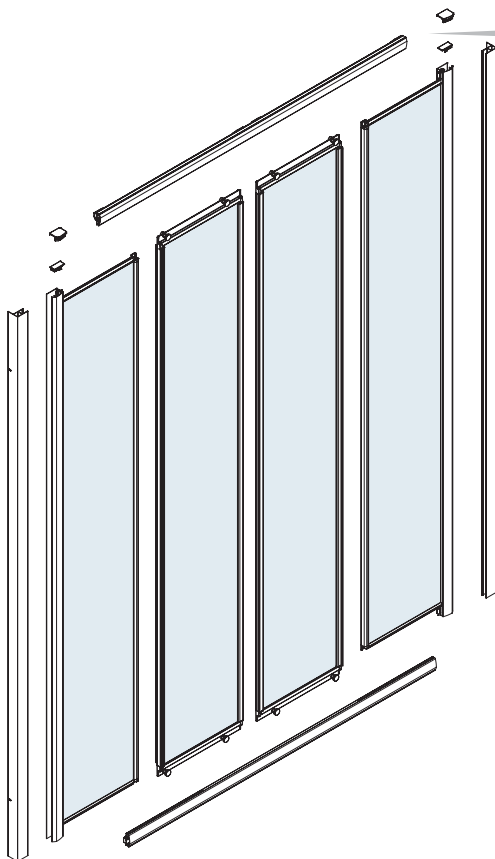
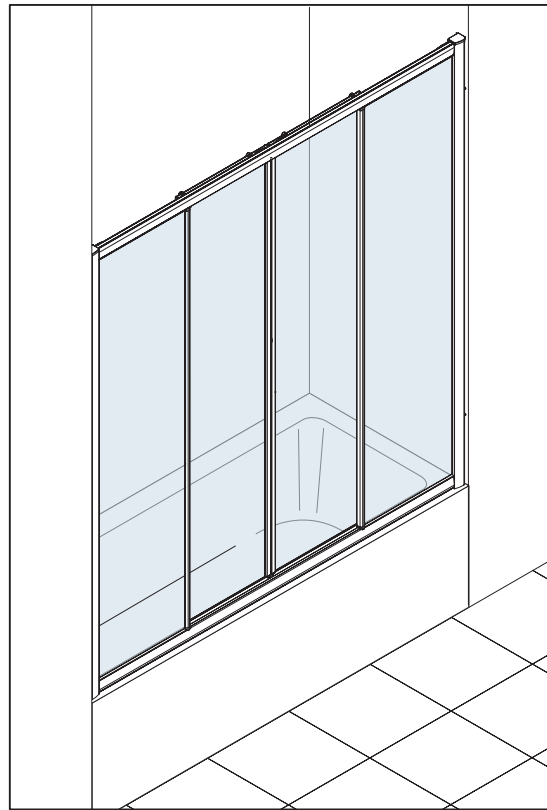

Vista dall'interno
Internal view

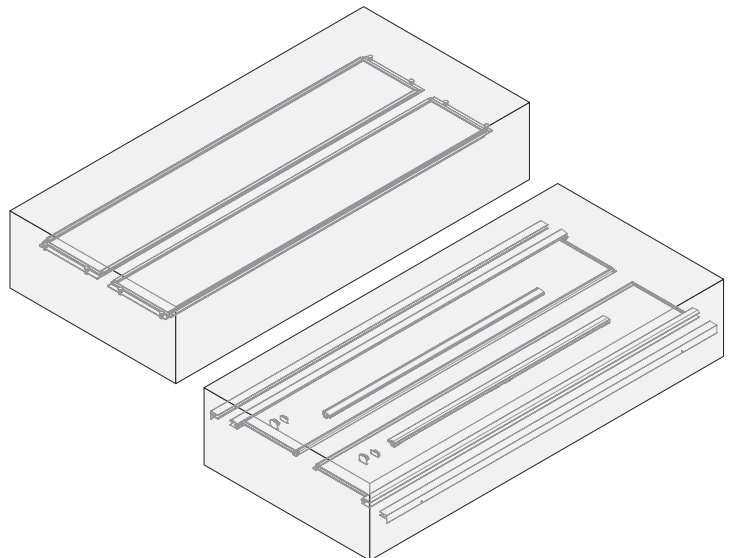

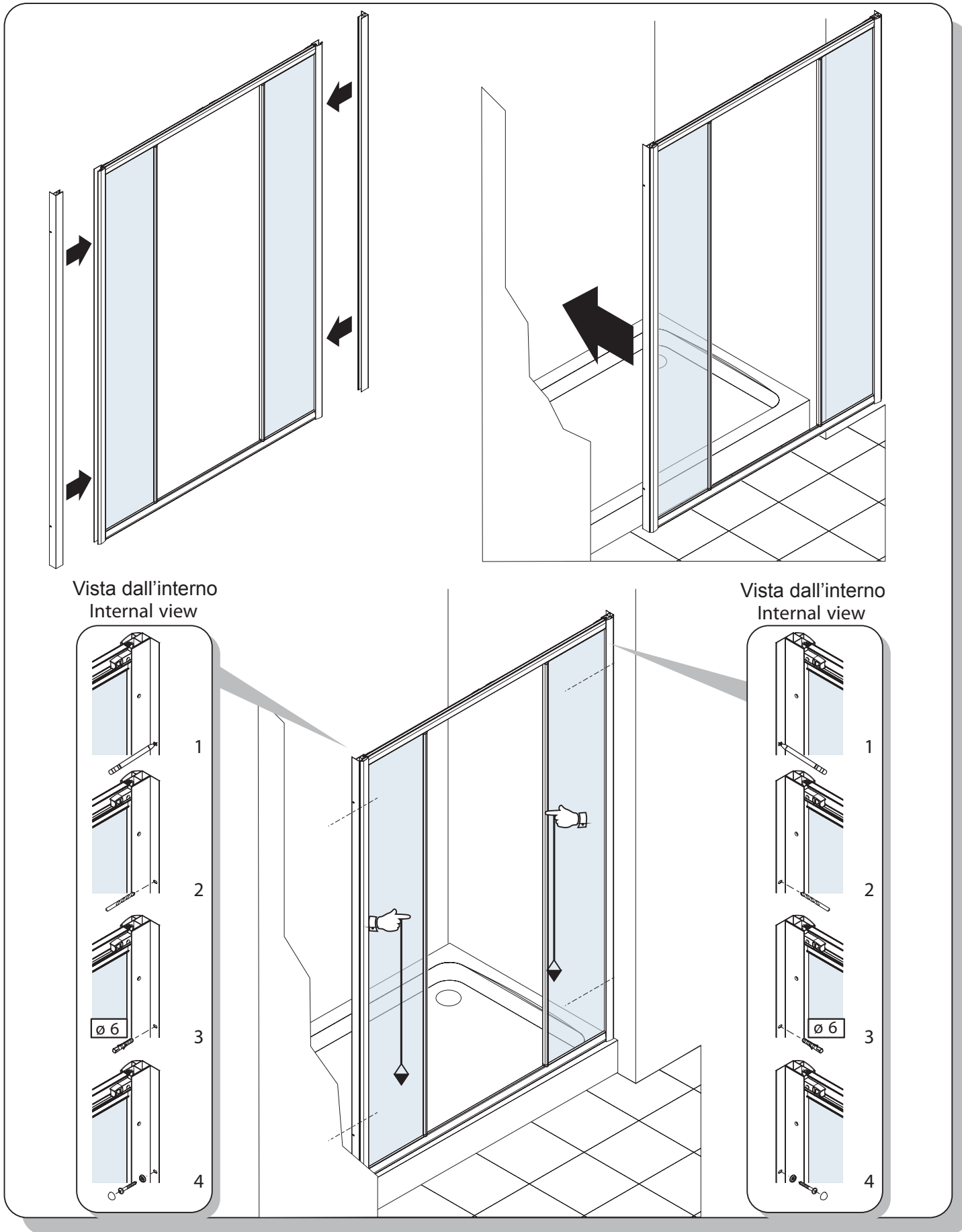

Vista dall'interno
Internal view

Vista dall'interno
Internal view

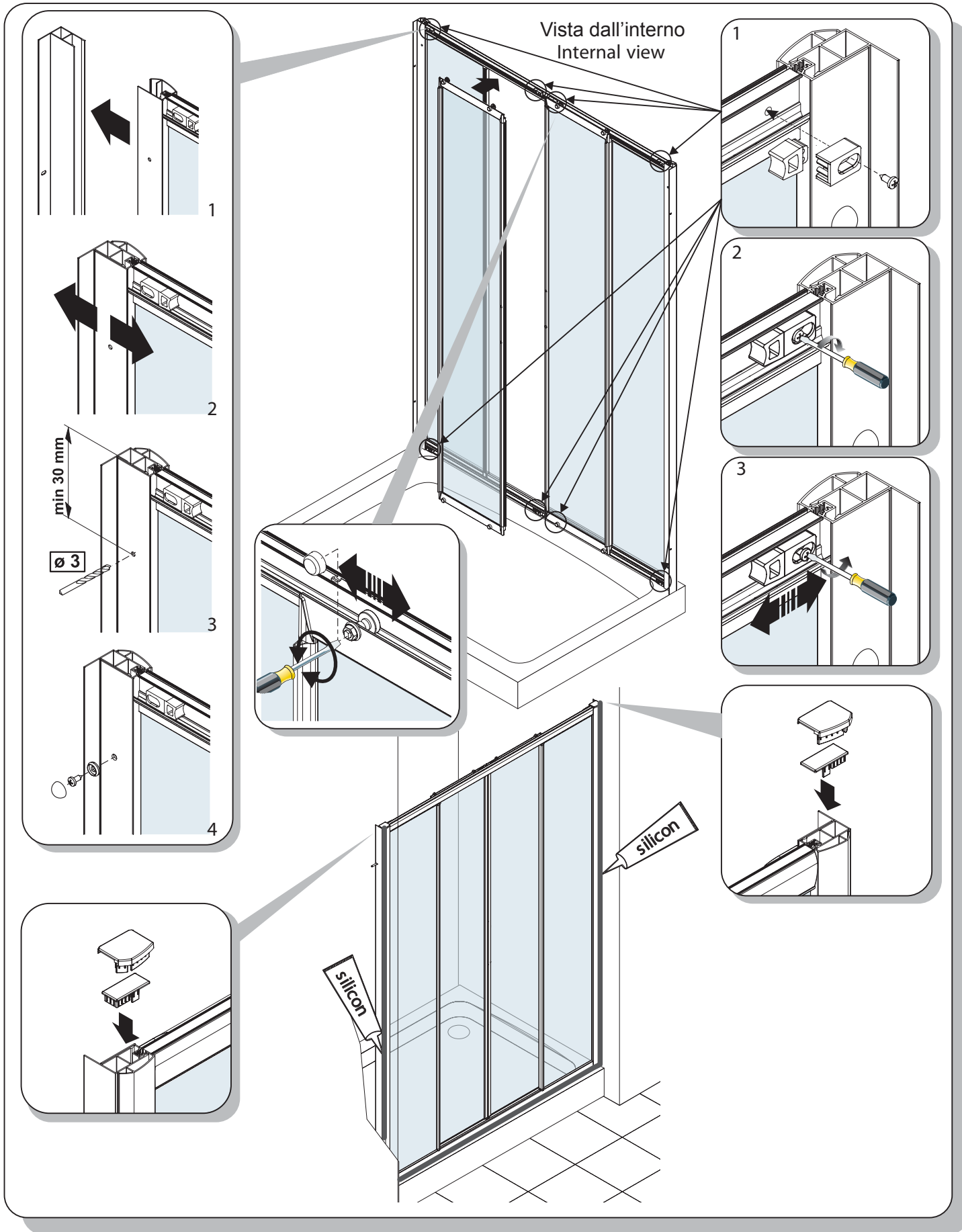

NL - BELANGRIJKE INSTRUKTIES VOOR DE KLANT

Voor het schoonmaken van uw douchecabine moet u alleen een zachte doek gebruiken. Gebruik nooit oplos-, was- en schuurmiddelen, omdat deze de glanzende verf- en laklaag zouden kunnen beschadigen .

IT - ISTRUZIONI IMPORTANTI PER IL CLIENTE

Per pulire la vostra cabina doccia dovete usare soltanto un panno morbido. Non usate mai detersivi, solventi o materiali abrasivi, perché potrebbero deteriorare le superfici lucide e verniciate.

BG - IMPORTANT INSTRUCTIONS FOR THE CLIENT

To clean your shower booth, please use only a soft cloth. Never use detergents, solvents, or abrasive materials, because they could damage the polished and varnished surfaces.

D - WICHTIGE INSTRUKTIONEN FÜR DEN KUNDEN

Für die Reinigung Ihrer Duschtrennwand dürfen Sie nur ein weiches Tuch benutzen. Benutzen Sie nie Putz- Scheuer- oder Lösemittel, weil sie die lackierten und glänzenden Flächen beschädigen Könnten.

F - INSTRUCTIONS IMPORTANTES POUR LE CLIENT

Pour nettoyer votre cabine douche, vous devez employer seulement un chiffon moelleux. N'employez jamais des détergents ou des matériaux abrasifs, parceque ils pourraient détériorer la surface polie e vernie.

ES - INSTRUCCIONES IMPORTANTES PARA EL CLIENTE

Para la belleza de vuestra cabina ducha usad solo un suave. No uséis jamas detergentes, disolventes o abrasivas, porque podrian dañar las superficie brillantes y pintadas.

